

SAMSUNG

Quick Start Manual

Guide de prise en main rapide

ST600



For more information, refer to the User Manual included on the supplied **CD-ROM**.

Pour des instructions plus détaillées, veuillez consulter le mode d'emploi complet sur le **CD-ROM** fourni avec l'appareil.

This Quick Start Manual has been specially designed to guide you through the basic functions and features of your device. Please read the Quick Start Manual and User Manual carefully to ensure safe and correct use.

Ce guide de prise en main rapide a été spécialement conçu pour vous permettre de découvrir les fonctions et caractéristiques de base de votre appareil. Afin de garantir une utilisation sûre et correcte, lisez attentivement le guide de prise en main rapide et le mode d'emploi.

ENG / SPA / FRE

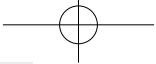

Contents



Health and safety information	2	1
Camera layout	4	15
Setting up your camera	5	14
Unpacking	5	
Inserting the battery and memory card	6	
Charging the battery	6	
Turning on your camera.....	7	
Using the touch screen	7	
Capturing photos or videos	8	25
Selecting a shooting mode using motion recognition.....	9	23
Playing files	9	68
Transferring files to a PC (Windows)	10	89
Specifications	11	113

Health and safety information



Warnings

Do not use your camera near flammable or explosive gases and liquids

Do not use your camera near fuels, combustibles, or flammable chemicals. Do not store or carry flammable liquids, gases, or explosive materials in the same compartment as the camera or its accessories.

Keep your camera away from small children and pets

Keep your camera and all accessories out of the reach of small children and animals. Small parts may cause choking or serious injury if swallowed. Moving parts and accessories may present physical dangers as well.

Prevent damage to subjects' eyesight

Do not use the flash in close proximity (closer than 1 m/3 ft) to people or animals. Using the flash too close to your subject's eyes can cause temporary or permanent damage.

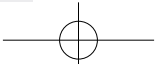
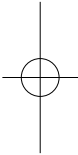

Handle and dispose of batteries and chargers with care

- Use only Samsung-approved batteries and chargers. Incompatible batteries and chargers can cause serious injuries or damage to your camera.
- Never place batteries or cameras on or in heating devices, such as microwave ovens, stoves, or radiators. Batteries may explode when overheated.



Handle and store your camera carefully and sensibly

- Do not allow your camera to get wet—liquids can cause serious damage. Do not handle your camera with wet hands. Water damage to your camera can void your manufacturer's warranty.
- Avoid using or storing your camera in dusty, dirty, humid, or poorly-ventilated areas to prevent damage to moving parts and internal components.

- Exercise caution when connecting cables or adapters and installing batteries and memory cards. Forcing the connectors, improperly connecting cables, or improperly installing batteries and memory cards can damage ports, connectors, and accessories.
- Do not insert foreign objects into any of your camera's compartments, slots, or access points. This type of damage may not be covered by your warranty.

Protect batteries, chargers, and memory cards from damage

- Avoid exposing batteries or memory cards to very cold or very hot temperatures (below 0° C/32° F or above 40° C/104° F). Extreme temperatures can reduce the charging capacity of your batteries and can cause memory cards to malfunction.
- Prevent memory cards from making contact with liquids, dirt, or foreign substances. If dirty, wipe the memory card clean with a soft cloth before inserting in your camera.

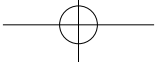

Camera layout

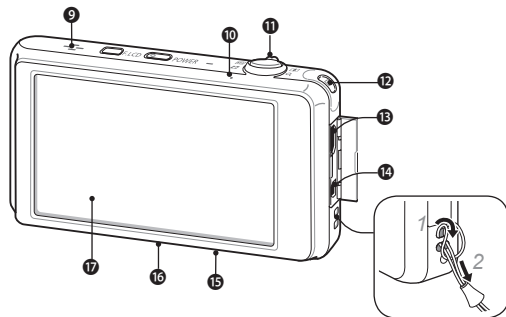
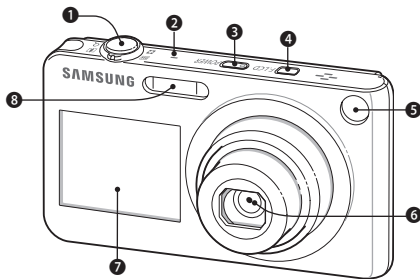

- | | |
|---|----------------------------|
| 1 | Shutter button |
| 2 | Microphone |
| 3 | POWER button |
| 4 | Front LCD button |
| 5 | AF-assist light/timer lamp |
| 6 | Lens |
| 7 | Front display |
| 8 | Flash |
| 9 | Speaker |

- | | |
|----|---|
| 10 | Status lamp |
| 11 | Zoom button |
| 12 | Playback button |
| 13 | USB and A/V port (Accepts USB cable or A/V cable) |
| 14 | HDMI port (Accepts HDMI cable) |
| 15 | Battery chamber cover |
| 16 | Tripod mount |
| 17 | Main display
(Referred to "Touch screen" in this manual) |

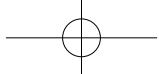

Setting up your camera

English

Unpacking



Camera



AC adapter/USB cable



Rechargeable battery



Strap



Cleaner



User Manual CD-ROM



Quick Start Manual

Optional accessories



Camera case



Memory card (microSD™)

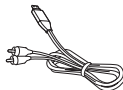

AV cable

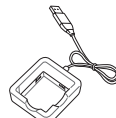

Battery charger

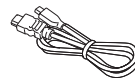

HDMI cable

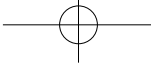

Setting up your camera

Inserting the battery and memory card

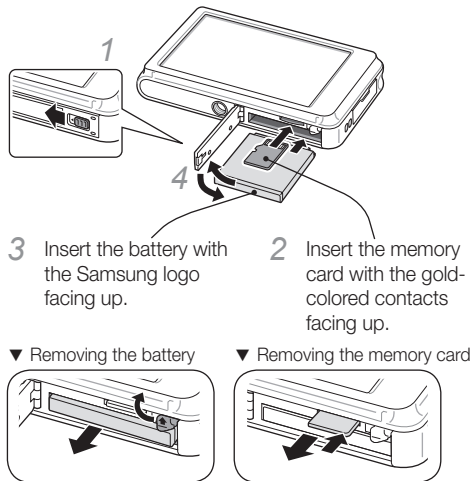

Push gently the card until the card disengages from the camera, and then pull it out of the slot.

6

Charging the battery

Before using the camera for the first time, you must charge the battery.

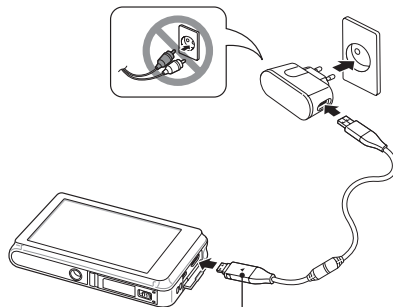

- Indicator light**
- Red: Charging
 - Green: Fully charged

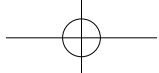

Turning on your camera

- 1 Press **[POWER]**.
 - The initial setup screen appears when you turn on your camera for the first time.

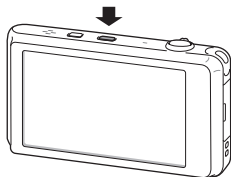

- 2 Select a language and a time zone, set the date and time, and select a date type.

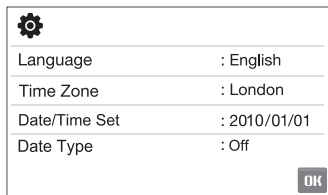

Using the touch screen

Use your finger to touch or drag on the touch screen.



Caution

Do not use other sharp objects, such as pens or pencils, to touch the screen. Doing so may damage the screen.



Touching

Touch an icon to open a menu or set an option.

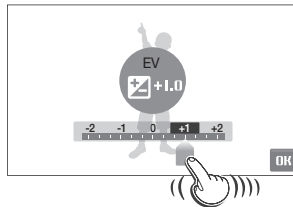

Dragging

Drag left or right to scroll horizontally.

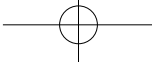

Capturing photos or videos

Taking a photo

- 1 Make sure that the camera is in the mode (Auto mode).
- 2 Align your subject in the frame.
- 3 Press **[Shutter]** halfway down to focus automatically.
 - A green frame means the subject in focus.

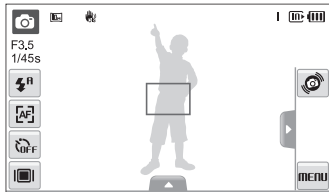

- 4 Press **[Shutter]** all the way down to take the photo.

Recording a video

- 1 Select → .
- 2 Align your subject in the frame.
- 3 Press **[Shutter]**.
 - To pause, select **||**.
 - To resume, select **●**.
- 4 Press **[Shutter]** again to stop recording.

Note

Number of photos by resolution (for 1 GB microSD™)

	Resolution	Super fine	Fine	Normal
	4320 X 3240	122	240	353
	4320 X 2880	137	267	391
	4000 X 3000	142	278	409
	4320 X 2432	163	320	471
	3264 X 2448	211	409	594
	2560 X 1920	335	637	908
	2048 X 1536	510	936	1,314
	1920 X 1080	762	1,373	1,931
	1024 X 768	1,626	2,575	3,090

These figures are measured under Samsung's standard conditions and may vary depending on shooting conditions and camera settings.

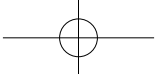

Selecting a shooting mode using motion recognition

In Shooting mode, tilt the camera while touching and holding .

Access the Movie mode

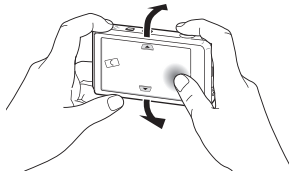

Access the Program mode





Access the Smart Auto mode

Note

Motion recognition may not work well if you hold the camera parallel to the ground.







Playing files

Viewing photos

- 1 Press **[Playback]**.
- 2 Drag files left or right to scroll through files.
 - You can also view files by tilting your camera.
 - You can select and hold  or  to view photos.

Viewing videos

- 1 Press **[Playback]** and select .
- 2 Use the following icons to control playback.

	Scan backward. The camera scans backward in 2X, 4X, and 8X increments when you select and hold  .
	Pause or resume playback
	Stop playback
	Scan forward. The camera scans forward in 2X, 4X, and 8X increments when you select and hold  .
	Adjust volume or mute sound

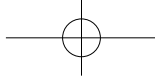

Transferring files to a PC (Windows)

- 1 Connect the camera to the PC with the USB cable.

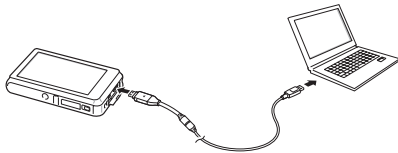

Note

Make sure that the **PC Software** option is set to **On** in the settings menu.

- 2 Turn on the camera.
 - The computer recognizes the camera automatically.
 - For Windows Vista and Windows 7, select **Run iStudio.exe** from the AutoPlay window.
- 3 Select a folder on your computer to save new files.
 - If your camera has no new files, the pop-up window for saving new files will not appear.

- 4 Select **Yes**.
 - New files will be transferred to your computer.
 - You can now use the Intelli-studio program.

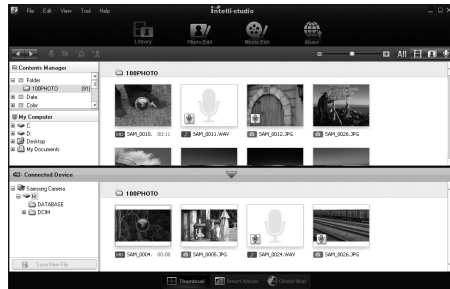

Note

About Intelli-studio

Intelli-studio is a built-in program that allows you to play back and edit files. You can upload files to websites, such as Flickr or YouTube. Also, you can download short animations for use in Children mode.

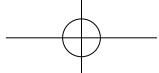

Specifications

Image sensor	<ul style="list-style-type: none"> Type: 1/2.3" (Approx. 7.76 mm) CCD Effective pixels: approx. 14.2 mega-pixels Total pixels: approx. 14.48 mega-pixels
Lens	<ul style="list-style-type: none"> Focal length: Schneider-KREUZNACH lens f = 4.9 - 24.5 mm (35 mm film equivalent: 27 - 135 mm) F-stop range: F3.5 (W) - F5.9 (T)
Display	<ul style="list-style-type: none"> Main Display: 3.5" (8.9 cm) Wide 1,152 K/Full Touch Screen Panel Front Display: 1.8" (4.6 cm) 116 K/ TFT LCD
Focusing	TTL auto focus (Multi AF, Center AF, Smart Face Recognition AF, Face Detection AF, Smart Touch AF, One Touch Shooting)
Shutter speed	<ul style="list-style-type: none"> Auto: 1/8 - 1/2,000 sec. Program: 1 - 1/2,000 sec. Night: 8 - 1/2,000 sec. Fireworks: 2 sec.
Storage	<ul style="list-style-type: none"> Internal memory: approx. 30 MB External memory (Optional): microSD™ card (up to 2 GB guaranteed), microSDHC™ card (up to 8GB guaranteed) <p>Internal memory capacity may not match these specifications.</p>
DC power input connector	20 pin
Rechargeable battery	Lithium-ion battery (SLB-07, 760mAh)
Dimensions (W x H x D)	103.5 X 59.9 X 19.9 mm
Weight	147.23 g (without battery and memory card)
Operating temperature	0 - 40° C
Operating humidity	5 - 85%

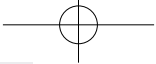

Contenido

Información sobre salud y seguridad	2	1
Diseño de la cámara	4	15
Configuración de la cámara	5	14
Desembalaje	5	
Insertar la batería y la tarjeta de memoria	6	
Cargar la batería.....	6	
Encender la cámara	7	
Usar la pantalla táctil	7	
Captura de fotografías o vídeos	8	25
Seleccionar un modo de disparo con reconocimiento de movimiento	9	23
Reproducción de archivos ...	9	68
Transferencia de archivos a un ordenador (para Windows) ...	10	89
Especificaciones	11	113



Información sobre salud y seguridad



Advertencias

No utilice la cámara cerca de líquidos y gases explosivos o inflamables

No utilice la cámara cerca de carburantes, combustibles o sustancias químicas inflamables. No almacene ni transporte líquidos inflamables, gases o materiales explosivos en el mismo compartimento en el que están la cámara o los accesorios.

Mantenga la cámara alejada del alcance de los niños y las mascotas

Mantenga la cámara y todos los accesorios fuera del alcance de los niños y los animales. Es posible que se traguen las piezas más pequeñas y, como consecuencia, se asfixien o sufran graves lesiones. Los accesorios y las piezas móviles también pueden causar daños físicos.

Evite dañar la vista del sujeto

No utilice el flash si está a una proximidad inferior a 1m de las personas o los animales. Si utiliza el flash cuando está demasiado cerca de los ojos del sujeto, puede producirle daños temporales o permanentes.

ES-2

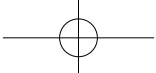

Utilice y deseche las baterías y los cargadores con cuidado

- Utilice únicamente baterías y cargadores aprobados por Samsung. Las baterías y los cargadores incompatibles pueden producirle graves lesiones o causar daños a la cámara.
- Nunca coloque las baterías o las cámaras dentro de dispositivos conductores de calor, como hornos de microondas, estufas o radiadores, ni sobre ellos. Las baterías pueden explotar si se recalientan.



Precauciones

Utilice y guarde la cámara con cuidado y de manera prudente

- No permita que la cámara se moje, ya que los líquidos pueden causarle graves daños. No manipule la cámara si tiene las manos mojadas. Si se producen daños en la cámara a causa del agua, se puede anular la garantía del fabricante.
- No utilice ni guarde la cámara en áreas en las que haya polvo, suciedad, humedad o poca ventilación, a fin de evitar daños en las partes móviles o en los componentes internos.

- Tenga cuidado al conectar los cables y los adaptadores y al instalar las baterías y las tarjetas de memoria. Si ejerce demasiada fuerza sobre los conectores, conecta de manera inapropiada los cables o instala de manera inadecuada las baterías y las tarjetas de memoria, puede dañar los puertos, los conectores y los accesorios.
- No inserte objetos extraños en ningún compartimento, ranura o punto de acceso de la cámara. Es posible que la garantía no cubra este tipo de daños.

Proteja las baterías, los cargadores y las tarjetas de memoria contra daños

- No exponga las baterías o las tarjetas de memoria a temperaturas demasiado bajas o demasiado altas (inferiores a 0 °C/32 °F o superiores a 40 °C/104 °F). Las temperaturas extremas pueden reducir la capacidad de carga de las baterías y generar un funcionamiento defectuoso de las tarjetas de memoria.
- Evite que las tarjetas de memoria entren en contacto con líquidos, suciedad o sustancias extrañas. Si la tarjeta de memoria se ensucia, límpiela con un paño suave antes de insertarla en la cámara.

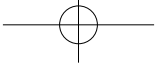

Diseño de la cámara

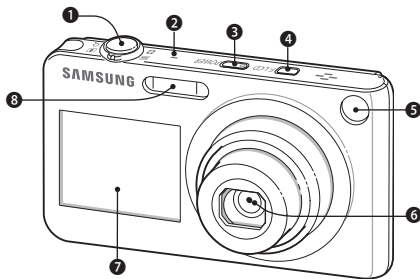

- 1 Boton del obturador
- 2 Micrófono
- 3 Botón de encendido y apagado
- 4 Botón LCD frontal
- 5 Luz AF auxiliar/luz de temporizador
- 6 Lente
- 7 Pantalla frontal
- 8 Flash
- 9 Altavoz

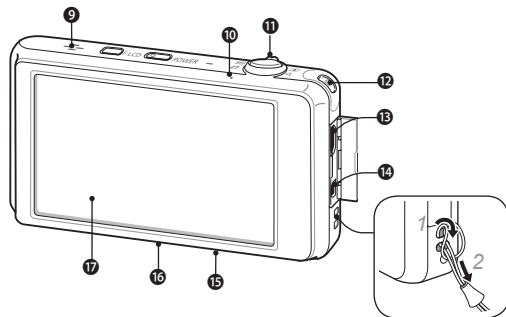

- 10 Luz indicadora de estado
- 11 Botón de zoom
- 12 Botón de reproducción
- 13 Puerto USB y A/V (Admite cables USB o A/V)
- 14 Puerto HDMI (Admite cable HDMI)
- 15 Cubierta de la cámara de la batería
- 16 Orificio para el montaje del trípode
- 17 Pantalla principal
(se denomina "Pantalla táctil" en este manual)

ES-4



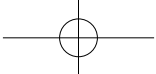

Configuración de la cámara

Desembalaje



Cámara



Fuente de alimentación/
cable USB



Batería recargable



Correa



Limpiador



CD-ROM del manual
del usuario



Manual de inicio rápido

Español

Accesorios opcionales



Estuche para la
cámara



Tarjeta de memoria
(microSD™)

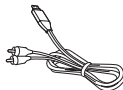

Cable AV

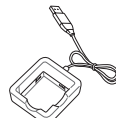

Cargador de
la batería

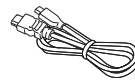

Cable HDMI

ES-5

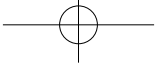

Configuración de la cámara

Insertar la batería y la tarjeta de memoria

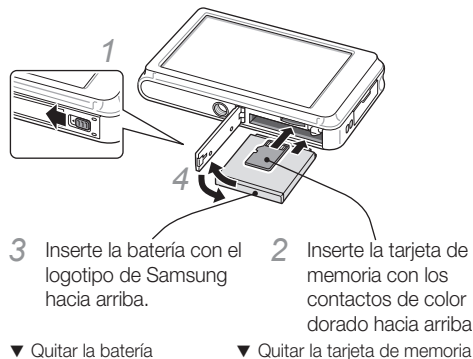

▼ Quitar la batería

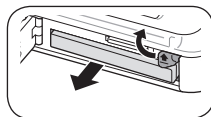

▼ Quitar la tarjeta de memoria

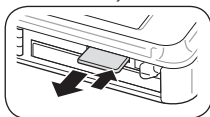

Ejerza una leve presión hasta que la tarjeta se desprenda de la cámara y, luego, retírela de la ranura.

Cargar la batería

Cargue la batería antes de utilizar la cámara.

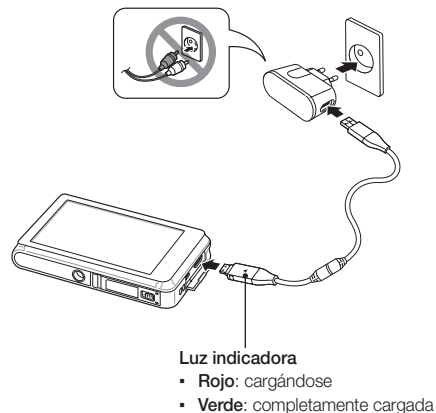

ES-6

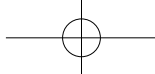

Encender la cámara

- 1 Pulse **[POWER]**.
 - Cuando encienda la cámara por primera vez, aparecerá la pantalla de configuración inicial.

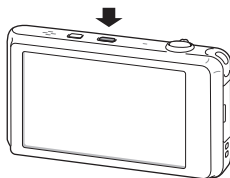

- 2 Seleccione el idioma y una zona horaria, configure la fecha y la hora, y seleccione un tipo de dato.

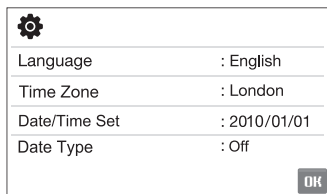

Usar la pantalla táctil

Utilice el dedo para tocar la pantalla táctil o para arrastrarse por ella.



No utilice objetos puntiagudos como lápices o portaminas para tocar la pantalla. Esto podría dañarla.

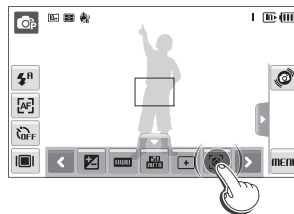

Tocar
Toque un icono para abrir un menú o para ajustar una opción.

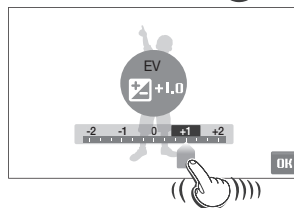

Arrastrar
Arrastre el dedo hacia la izquierda o hacia la derecha para desplazarse de forma horizontal.

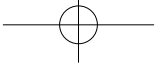

Captura de fotografías o vídeos

Tomar una fotografía

- 1 Asegúrese de que la cámara esté en (modo Auto).
- 2 Alinee el sujeto en el marco.
- 3 Pulse **[Obturador]** hasta la mitad para utilizar el enfoque automático.
 - Si aparece un cuadro verde, significa que el sujeto está enfocado.

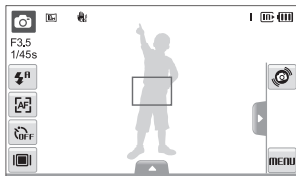

- 4 Pulse **[Obturador]** completamente para tomar la fotografía.

Grabar un vídeo

- 1 Seleccione → .
- 2 Alinee el sujeto en el marco.
- 3 Pulse **[Obturador]**.
 - Para pausar, seleccione .
 - Para reanudar, seleccione .
- 4 Pulse **[Obturador]** nuevamente para detener la grabación.

* Nota

Cantidad de fotografías por resolución

(para microSD™ de 1 GB)

	Resolución	Superfina	Fina	Normal
	4320 X 3240	122	240	353
	4320 X 2880	137	267	391
	4000 X 3000	142	278	409
	4320 X 2432	163	320	471
	3264 X 2448	211	409	594
	2560 X 1920	335	637	908
	2048 X 1536	510	936	1314
	1920 X 1080	762	1373	1931
	1024 X 768	1626	2575	3090

Estas son medidas tomadas en condiciones estándar, establecidas por Samsung, y pueden variar según las condiciones de disparo y la configuración de la cámara.

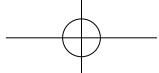

Seleccionar un modo de disparo con reconocimiento de movimiento

En el modo de disparo, incline la cámara mientras mantiene pulsado .

Acceda al modo Imagen mov

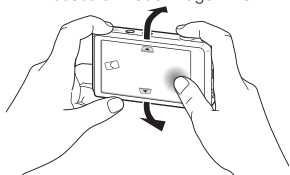

Acceda al modo Programa



Acceda al modo Auto inteligente





Nota

Si sostiene la cámara en sentido paralelo al suelo, es posible que el reconocimiento de movimiento no funcione correctamente.

Reproducción de archivos

Ver fotografías

- 1 Pulse **[Reproducción]**.
- 2 Para desplazarse por los archivos, arrástrelos hacia la izquierda o hacia la derecha.
 - También puede inclinar la cámara a fin de ver los archivos.
 - Para ver las fotografías puede seleccionar y mantener pulsada  o .

Ver vídeos

- 1 Pulse **[Reproducción]** y seleccione .
- 2 Use los siguientes iconos para controlar la reproducción.



Permite retroceder. La cámara retrocede en incrementos de 2X, 4X y 8X al seleccionar y pulsar .



Permite pausar o reanudar la reproducción.



Permite detener la reproducción.



Permite avanzar. La cámara avanza en incrementos de 2X, 4X y 8X al seleccionar y pulsar .



Permite ajustar el volumen o silenciar los sonidos.

ES-9

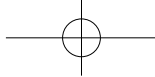

Transferencia de archivos a un ordenador (para Windows)

- 1 Conecte la cámara a su PC con el cable USB.

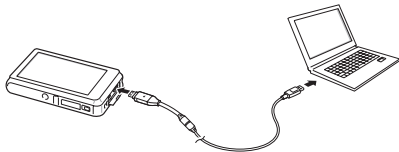

Nota

Asegúrese de que la opción **Software del PC** esté configurada en **Encendido** en el menú de ajustes.

- 2 Encienda la cámara.
 - El ordenador reconoce la cámara automáticamente.
 - En Windows Vista y Windows 7, seleccione **Run iStudio.exe** en la ventana Reproducción automática.
- 3 Seleccione una carpeta en el ordenador para guardar los archivos nuevos.
 - Si su cámara no tiene archivos nuevos, no aparecerá la ventana emergente para guardar nuevos archivos.

- 4 Seleccione **Sí**.
 - Los archivos nuevos se transferirán al ordenador. Ahora puede utilizar el programa Intelli-studio.

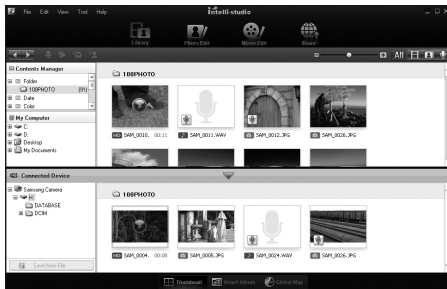

Nota

Sobre Intelli-studio

Intelli-studio es un programa incorporado que le permite reproducir y editar archivos. Puede cargar archivos en sitios web, como Flickr o YouTube. También, puede descargar animaciones breves para usar en el modo Niños.

ES-10

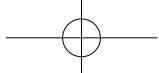

Especificaciones

Sensor de imagen	<ul style="list-style-type: none">• Tipo: 1/2,3" (aprox. 7,76 mm) CCD• Píxeles reales: aprox. 14,2 megapíxeles• Píxeles totales: aprox. 14,48 megapíxeles
Lente	<ul style="list-style-type: none">• Distancia focal: lente Schneider-KREUZNACH f = de 4,9 a 24,5 mm (equivalente en película de 35 mm: de 27 a 135 mm)• Rango de apertura del objetivo: F3,5 (W) y F5,9 (T)
Pantalla	<ul style="list-style-type: none">• Pantalla principal: Panel completo de pantalla táctil ancha de 3,5" (8,9 cm) y 1152 K• Pantalla frontal: LCD TFT de 1,8" (4,6 cm) y 116 K
Enfoque	Enfoque automático TTL (Multi af, Af central, Reconocimiento inteligente de rostros, AF de detección de rostros, AF táctil inteligente, Disparo con un toque)
Velocidad del obturador	<ul style="list-style-type: none">• Auto: de 1/8 a 1/2000 s• Programa: de 1 a 1/2000 s• Nocturno: de 8 a 1/2000 s• Fuegos Artificiales: 2 s
Almacenamiento	<ul style="list-style-type: none">• Memoria interna: aprox. 30 MB• Memoria externa (opcional): Tarjeta microSD™ (hasta 2 GB garantizados), tarjeta microSDHC™ (hasta 8 GB garantizados) <p>Es posible que la capacidad de la memoria interna no coincida con estas especificaciones.</p>
Conector de entrada de CC	20 pines
Batería recargable	Batería de litio (SLB-07, 760 mAh)
Dimensiones (alto x ancho x profundidad)	103,5 x 59,9 x 19,9 mm
Peso	147,23 g (sin la batería ni la tarjeta de memoria)
Temperatura de funcionamiento	De 0 °C a 40 °C
Humedad de funcionamiento	De 5 a 85%

ES-11

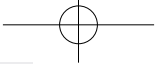

Table des matieres

Informations relatives à la santé et à la sécurité	2	1
Présentation de l'appareil photo	4	15
Assemblage de votre appareil photo	5	14
Contenu du coffret	5	
Insertion de la batterie et de la carte mémoire	6	
Chargement de la batterie.....	6	
Mise en route de l'appareil photo	7	
Écran tactile	7	
Prise de vues photo ou vidéo	8	25
Sélection d'un mode de prise de vue à l'aide de la fonction de reconnaissance des mouvements	9	23
Lecture de fichiers	9	68
Transfert de fichiers vers un PC (Windows)	10	89
Caractéristiques	11	113



Informations relatives à la santé et à la sécurité



Avertissements

N'utilisez pas l'appareil photo à proximité de gaz et de liquides inflammables ou explosifs

N'utilisez pas l'appareil à proximité de combustibles ou de produits chimiques inflammables. Ne transportez et ne stockez jamais de liquides inflammables, de gaz ou de matériaux explosifs dans le même emplacement que l'appareil ou ses accessoires.

Ne laissez pas l'appareil photo à la portée d'enfants en bas âge et d'animaux domestiques

Tenez l'appareil, ses pièces et ses accessoires, hors de portée des enfants en bas âge et des animaux. L'ingestion de petites pièces peut provoquer un étouffement ou des blessures graves. Les parties détachables et les accessoires représentent également un danger.

Évitez d'endommager la vue des sujets photographiés

N'utilisez pas le flash trop près (moins d'un mètre) des personnes et des animaux. L'utilisation du flash trop près des yeux du sujet peut provoquer des lésions temporaires ou permanentes.

FR-2

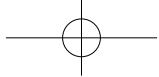

Utilisez les batteries et les chargeurs avec précaution et respectez les consignes de recyclage

- Utilisez uniquement des batteries et des chargeurs Samsung. L'utilisation de batteries et de chargeurs incompatibles peut provoquer des blessures graves ou endommager votre appareil.
- Ne posez jamais les batteries ou l'appareil à l'intérieur ou au-dessus d'un dispositif chauffant, tel qu'un four à micro-ondes, une cuisinière ou un radiateur. En cas de surchauffe, les batteries risquent d'exploser.



Attention

Manipulez et stockez votre appareil avec soins

- Évitez tout contact avec des liquides qui risqueraient d'endommager sérieusement votre appareil photo. N'utilisez pas l'appareil avec les mains mouillées. L'eau peut endommager votre appareil photo et entraîner l'annulation de la garantie du fabricant.
- Évitez d'utiliser et de stocker votre appareil dans un endroit poussiéreux, sale, humide ou mal ventilé afin de ne pas endommager ses composants internes.

- Lors du branchement des cordons et du chargeur et de l'insertion des batteries et des cartes mémoire, agissez prudemment. Enfoncer les cordons avec force ou sans précaution et insérer les batteries et les cartes mémoire de manière incorrecte peut endommager les prises et les accessoires.
- N'introduisez pas de corps étrangers dans les compartiments, les logements ou les ouvertures de l'appareil photo. Les dysfonctionnements qui s'en suivraient ne seront pas couverts par votre garantie.

Protégez les batteries, les chargeurs et les cartes mémoire

- Évitez d'exposer les batteries et les cartes mémoire à des températures extrêmes (inférieures à 0 °C / 32 °F ou supérieures à 40 °C / 104 °F). Les températures extrêmes peuvent réduire les capacités de chargement des batteries et provoquer des dysfonctionnements des cartes mémoire.
- Évitez tout contact des cartes mémoire avec des liquides, de la poussière ou des corps étrangers. Si la carte mémoire est sale, nettoyez-la avec un chiffon doux avant de l'introduire dans l'appareil photo.

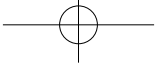

Présentation de l'appareil photo

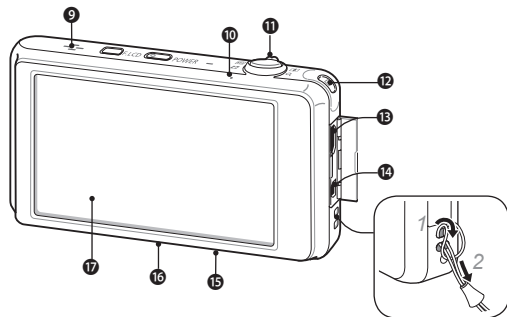
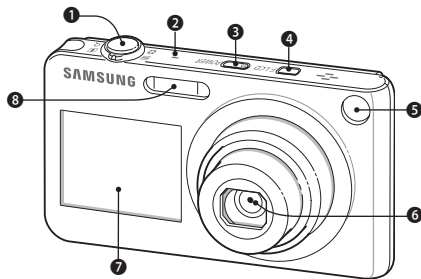

- | | |
|---|---|
| 1 | Déclencheur |
| 2 | Microphone |
| 3 | Interrupteur Marche/Arrêt |
| 4 | Bouton de l'écran LCD frontal |
| 5 | Capteur Autofocus/Voyant du retardateur |
| 6 | Objectif |
| 7 | Écran frontal |
| 8 | Flash |
| 9 | Haut-parleur |

- | | |
|----|--|
| 10 | Voyant Indicateur |
| 11 | Touche zoom |
| 12 | Touche Lecture |
| 13 | Port USB et port Audio/Vidéo
(Compatible avec un câble USB ou un câble Audio/
Vidéo) |
| 14 | Port HDMI (Compatible avec les câbles HDMI) |
| 15 | Trappe batterie |
| 16 | Fixation du pied |
| 17 | Écran principal
(appelé « Écran tactile » dans ce mode d'emploi) |

FR-4

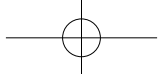

Assemblage de votre appareil photo

Contenu du coffret



Appareil photo



Adaptateur secteur/
câble USB



Batterie
rechargeable



Dragonne



Chiffon doux



Mode d'emploi
(CD-ROM)



Manuel de démarrage
rapide

Français

Accessoires en option



Étui de l'appareil
photo



Carte mémoire
(microSD™)

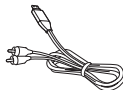

Câble Audio/
Vidéo

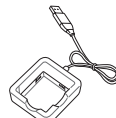

Chargeur de batterie

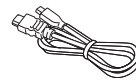

Câble HDMI

FR-5

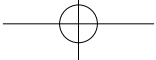

Assemblage de votre appareil photo

Insertion de la batterie et de la carte mémoire

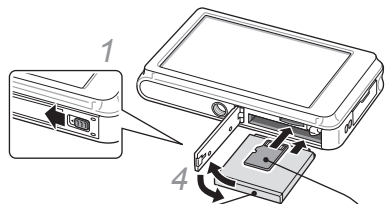

3 Insérez la batterie avec le logo Samsung orienté vers le haut.

2 Insérez une carte mémoire en orientant les contacts dorés.

▼ Retrait de la batterie

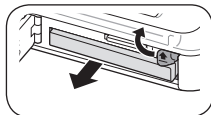

▼ Retrait de la carte mémoire

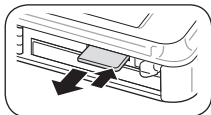

Poussez doucement jusqu'à faire sortir la carte de son logement, puis retirez-la entièrement.

FR-6

Chargement de la batterie

Assurez-vous de charger la batterie avant d'utiliser l'appareil photo.

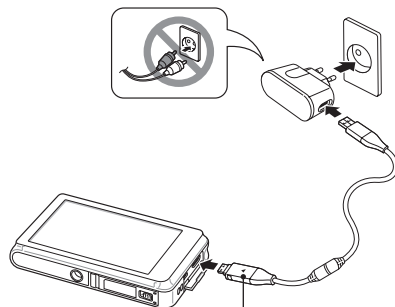

Voyant lumineux

- Rouge : Chargement
- Vert : Chargement terminé

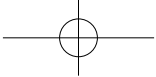

Mise en route de l'appareil photo

- Appuyez sur le bouton Marche/Arrêt.
 - L'écran de configuration initiale s'affiche lorsque vous allumez votre appareil photo pour la première fois.

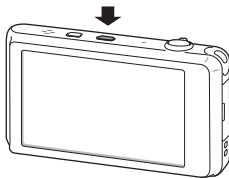

- Sélectionnez une langue et un fuseau horaire, réglez la date et l'heure et choisissez un type de date.

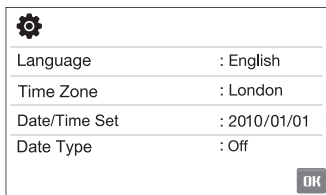

Écran tactile

Utilisez le doigt pour toucher ou parcourir l'écran tactile.



N'utilisez pas d'objets pointus tels que des crayons ou des stylos pour toucher l'écran. Vous risqueriez d'endommager l'écran.

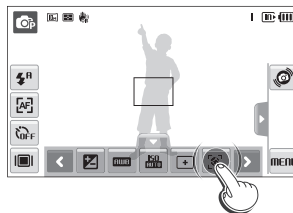

Appuyer
Appuyez sur une icône pour ouvrir un menu ou régler une option.

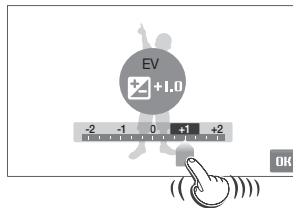

Faire glisser
Faites glisser vers la gauche ou vers la droite pour un défilement horizontal.

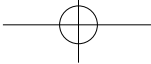

Prise de vues photo ou vidéo

Prendre une photo

- 1 L'appareil photo doit être en mode (Auto).
- 2 Cadrez le sujet à photographier.
- 3 Appuyez à mi-chemin sur le déclencheur pour une mise au point automatique.
 - Un cadre vert signifie que le sujet est mis au point.

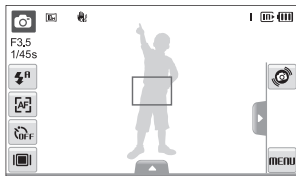

- 4 Appuyez à fond sur le déclencheur pour prendre la photo.

Filmer une séquence vidéo

- 1 Sélectionnez → .
- 2 Cadrez le sujet à photographier.
- 3 Appuyez sur le déclencheur.
 - Pour interrompre l'enregistrement, sélectionnez .
 - Pour reprendre l'enregistrement, sélectionnez .
- 4 Appuyez à nouveau sur le déclencheur pour arrêter l'enregistrement.

Remarque

Nombre de photos en fonction de la résolution

(pour une carte microSD™ de 1 Go)

	Résolution	Maximale	Élevée	Normale
PH	4320 X 3240	122	240	353
PH	4320 X 2880	137	267	391
PH	4000 X 3000	142	278	409
PH	4320 X 2432	163	320	471
PH	3264 X 2448	211	409	594
PH	2560 X 1920	335	637	908
PH	2048 X 1536	510	936	1 314
PH	1920 X 1080	762	1 373	1 931
PH	1024 X 768	1 626	2 575	3 090

Ces chiffres proviennent des mesures effectuées par Samsung dans des conditions normales. Ils peuvent varier en fonction des paramètres et des conditions de prise de vue.

FR-8

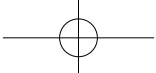

Sélection d'un mode de prise de vue à l'aide de la fonction de reconnaissance des mouvements

En mode Prise de vue, faites pivoter l'appareil photo en maintenant le doigt appuyé sur .

Accéder au mode Vidéo

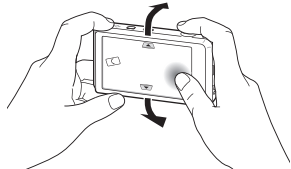

Accéder au mode Programme

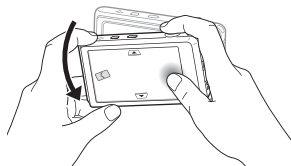

Accéder au mode Scènes Automatique

Remarque

La reconnaissance des mouvements peut ne pas fonctionner correctement si l'appareil est parallèle au sol.



Lecture de fichiers

Visionner des photos

- 1 Appuyez sur **[Lecture]**.
- 2 Faites glisser les fichiers vers la gauche ou vers la droite pour les faire défiler.
 - Vous pouvez également afficher des fichiers en faisant pivoter l'appareil photo.
 - Vous pouvez maintenir **◀** ou **▶** enfoncée pour visionner des photos.

Afficher des vidéos

- 1 Appuyez sur **[Lecture]** et sélectionnez .
- 2 Utilisez les icônes suivantes pour contrôler la lecture.

 Retour arrière. Lorsque vous maintenez la touche  enfoncée, l'appareil photo effectue une recherche en arrière par incréments de 2X, 4X, et 8X.

 Mettre en pause ou reprendre après une pause.

 Arrêter la lecture.

 Avance rapide. Lorsque vous maintenez la touche  enfoncée, l'appareil photo effectue une recherche en avant par incréments de 2X, 4X, et 8X.

 Régler le volume ou désactiver le son.

FR-9

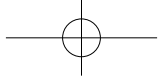

Transfert de fichiers vers un PC (Windows)

- 1 Branchez l'appareil au PC à l'aide du câble USB.

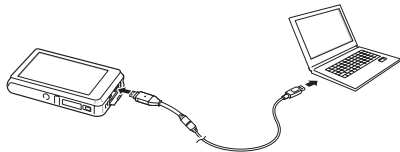

Remarque

Vérifiez que l'option **Logiciel PC** est réglée sur **Marche** dans le menu des paramètres.

- 2 Allumez l'appareil photo.
 - L'ordinateur reconnaît l'appareil photo automatiquement.
 - Pour Windows Vista et Windows 7, sélectionnez **Run iStudio.exe** dans la fenêtre AutoPlay.
- 3 Sélectionnez un dossier sur votre ordinateur dans lequel vous allez enregistrer les nouveaux fichiers.
 - Si votre appareil photo ne comporte pas de nouveaux fichiers, la fenêtre permettant d'enregistrer de nouveaux fichiers n'apparaît pas sur votre écran.

- 4 Sélectionnez **Oui**.
 - Les nouveaux fichiers seront transférés sur votre ordinateur. Vous pouvez à présent utiliser le programme Intelli-studio.

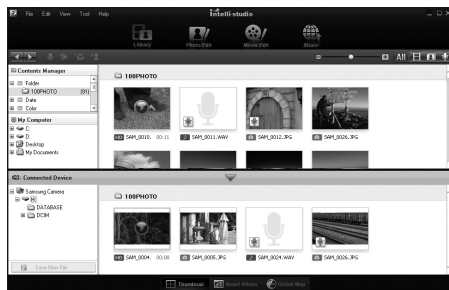

Remarque

À propos d'Intelli-studio

Intelli-studio est un programme intégré qui vous permet de lire et de modifier des fichiers. Ce logiciel permet également de télécharger des fichiers vers des sites Web tels que Flickr ou YouTube. Vous pouvez, par ailleurs, télécharger de courtes animations que vous utiliserez en mode Enfants.

FR-10

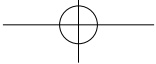

Caractéristiques

Capteur d'images	<ul style="list-style-type: none">Type : CCD 1/2,3" (environ 7,76 mm)Pixels effectifs : environ 14,2 mégapixelsNombre total de pixels : environ 14,48 mégapixels
Objectif	<ul style="list-style-type: none">Distance focale : Objectif Schneider-KREUZNACH f = 4,9 - 24,5 mm (équivalent à un film 35 mm : 27 - 135 mm)Plage d'ouverture de l'objectif : F3,5 (W) - F5,9 (T)
Écran	<ul style="list-style-type: none">Écran principal : 3,5" (8,9 cm) grand format (1 152 000 pixels) avec écran tactile completÉcran frontal : LCD TFT 1,8" (4,6 cm) 116 000 pixels
Mise au point	Mise au point auto TTL (Mise au point multiple, Mise au point au centre, Mise au point reconnaissance intelligente des visages, Mise au point détection des visages, Mise au point tactile intelligente, Prise de vue 1 touche)
Vitesse d'obturation	<ul style="list-style-type: none">Automatique : 1/8 - 1/2 000 s.Programme : 1 - 1/2 000 s.Nuit : 8 - 1/2 000 s.Feux d'artifice : 2 s.
Stockage	<ul style="list-style-type: none">Mémoire interne : environ 30 MoMémoire externe (en option) : Carte microSD™ (jusqu'à 2 Go garantis), Carte microSDHC™ (jusqu'à 8 Go garantis) <p>La capacité de la mémoire interne peut varier par rapport à ces caractéristiques.</p>
Connecteur d'alimentation CC	20 broches
Batterie rechargeable	Batterie lithium-ion (SLB-07, 760 mAh)
Dimensions (l x h x p)	103,5 x 59,9 x 19,9 mm
Poids	147,23 g (sans la batterie ni la carte mémoire)
Température de fonctionnement	0 - 40°C
Humidité	5 - 85%

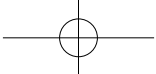

Please refer to the warranty that came with your product
or visit our website <http://www.samsungimaging.com/> or
<http://www.samsung.com/> for after-sales service or inquiries.

Pour toute question ou demande concernant le service
après-vente, veuillez consulter les conditions de garantie
accompagnant votre produit ou rendez-vous sur le site Web
<http://www.samsungimaging.com/> ou <http://www.samsung.com/>.



AD68-05404A (1.0)